

MIDDLETON SIMPLICITY

BY-PASS SHOWER SYSTEM

FEATURES:

The SIMPLICITY Shower System attaches to a upper slide rail which allows both shower doors to slide very easily.

- Light weight aluminum frame with polished steel hardware.
- Easy access for cleaning with very accessible wall jams.
- 5/16" (8mm) thick tempered
- Out-of-square adjustability

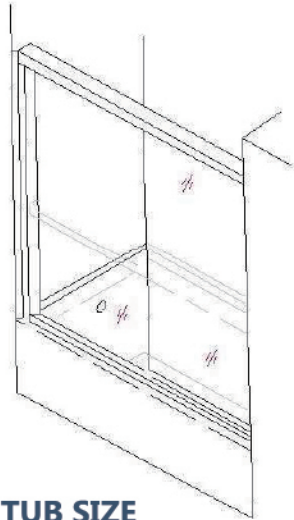

TUB SIZE

60" X 62"

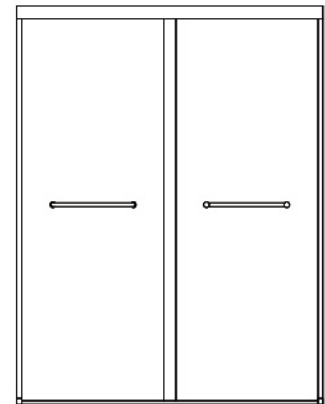

SHOWER SIZES

48" X 74"

60" X 74"

66" X 74"

Middleton Associates, LLC

8 Vineland Drive Barrington, Rhode Island 02806

401-588-4646

ma_LLC@cox.net

MIDDLETON SIMPLICITY

BY-PASS SHOWER SYSTEM

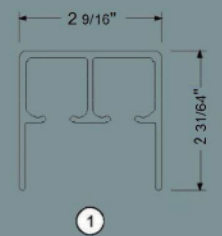
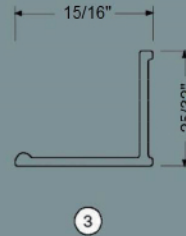
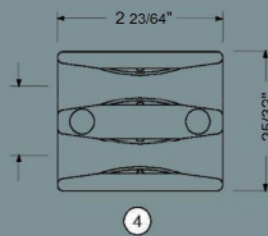
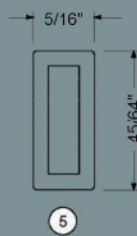
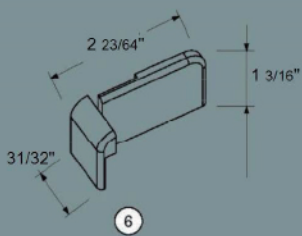
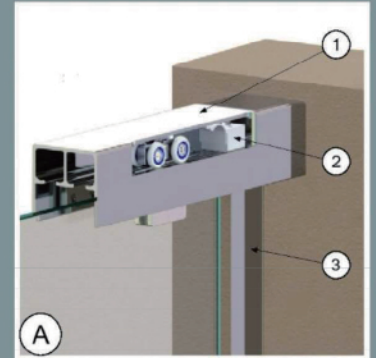
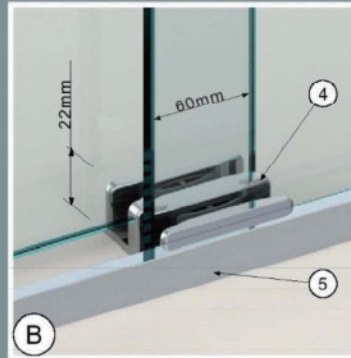
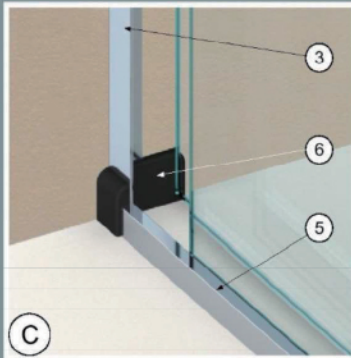
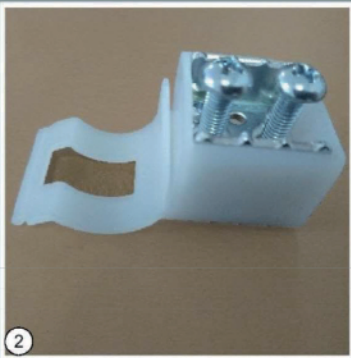
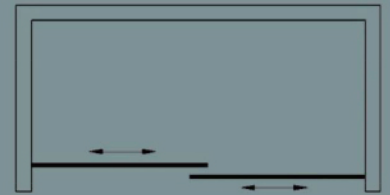

Middleton Associates, LLC

8 Vineland Drive Barrington, Rhode Island 02806

401-588-4646

ma_LLC@cox.net

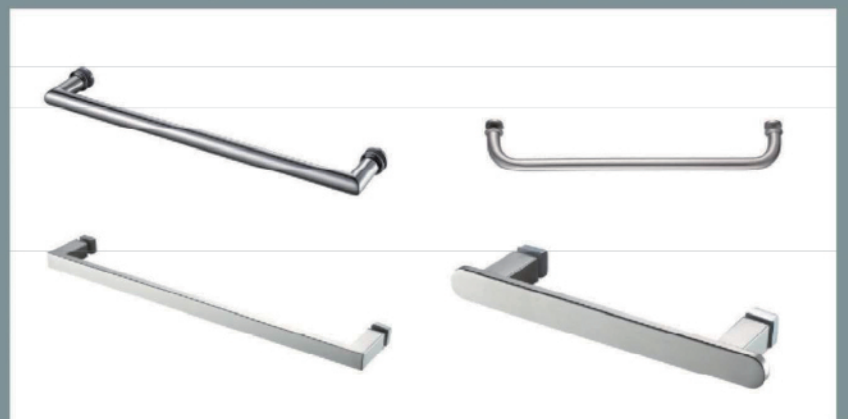

TOP CLIPS SUPPORT
W/ROLLERS

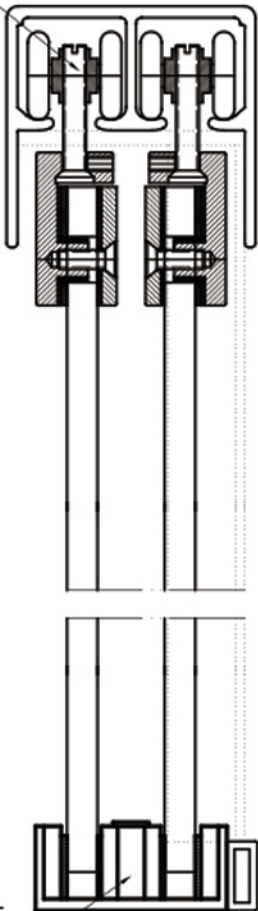

PLASTIC GUIDE
(BOTTOM TRACK)



PLAN VIEW

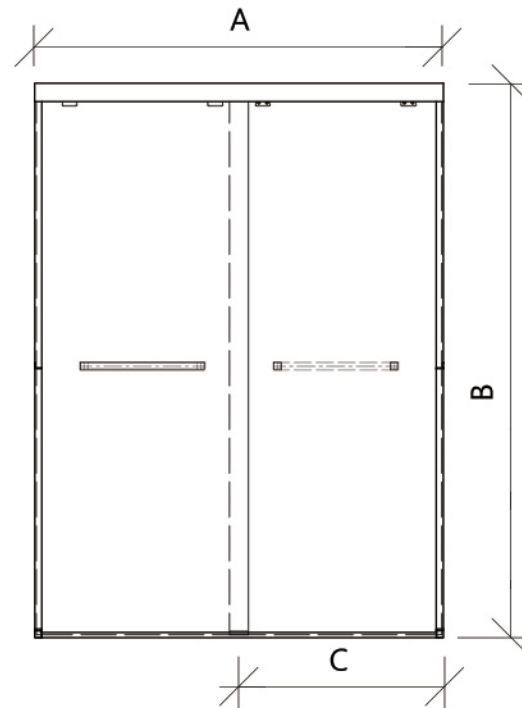

MODEL	A (MIN-MAX FINISH OPENING)	B (HEIGHT)	C (APROX. WALK THRU)
S-6260	56" - 60"	62"	28"
S-7466	62" - 66"	74"	32"
S-7460	56" -60"	74"	28"
S-7448	44" -48"	74"	23"

Middleton Associates, LLC

8 Vineland Drive Barrington, Rhode Island 02806

401-588-4646

ma_LLC@cox.net

MIDDLETON SIMPLICITY

APPROVED BY _____

COMPANY _____

DATE _____

MIDDLETON OMNI SHOWER BARN DOOR SYSTEM

FEATURES:

- Adjustable fit
- 3/8" (10mm) or 5/16" (8mm) fixed panel with sliding tempered glass door panel
- Continuous door guide for smooth & effortless sliding
- 304#Stainless steel hardware
- Polished / brushed finish available



STANDARD SIZE: 60" X 74"

CUSTOM SIZES AVAILABLE

Middleton Associates, LLC

8 Vineland Drive Barrington, Rhode Island 02806

401-588-4646

ma_LLC@cox.net

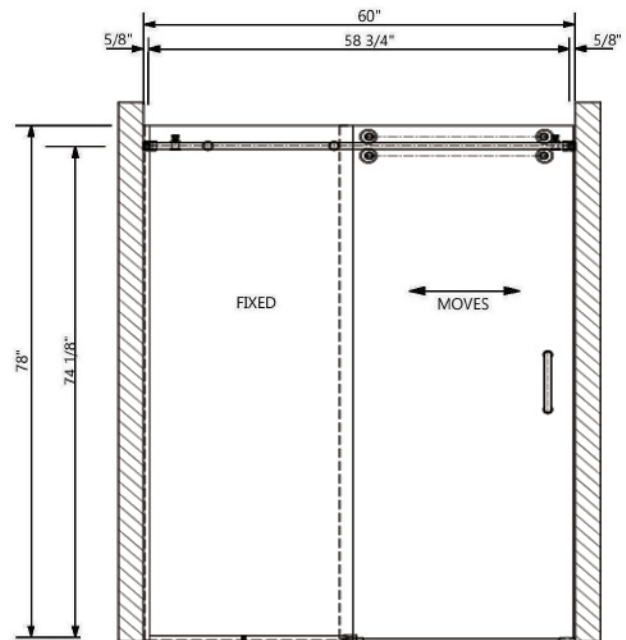

It's all about the glide!



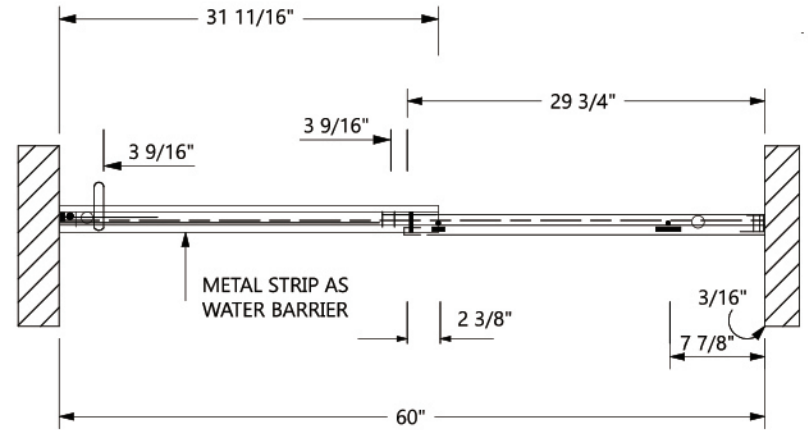
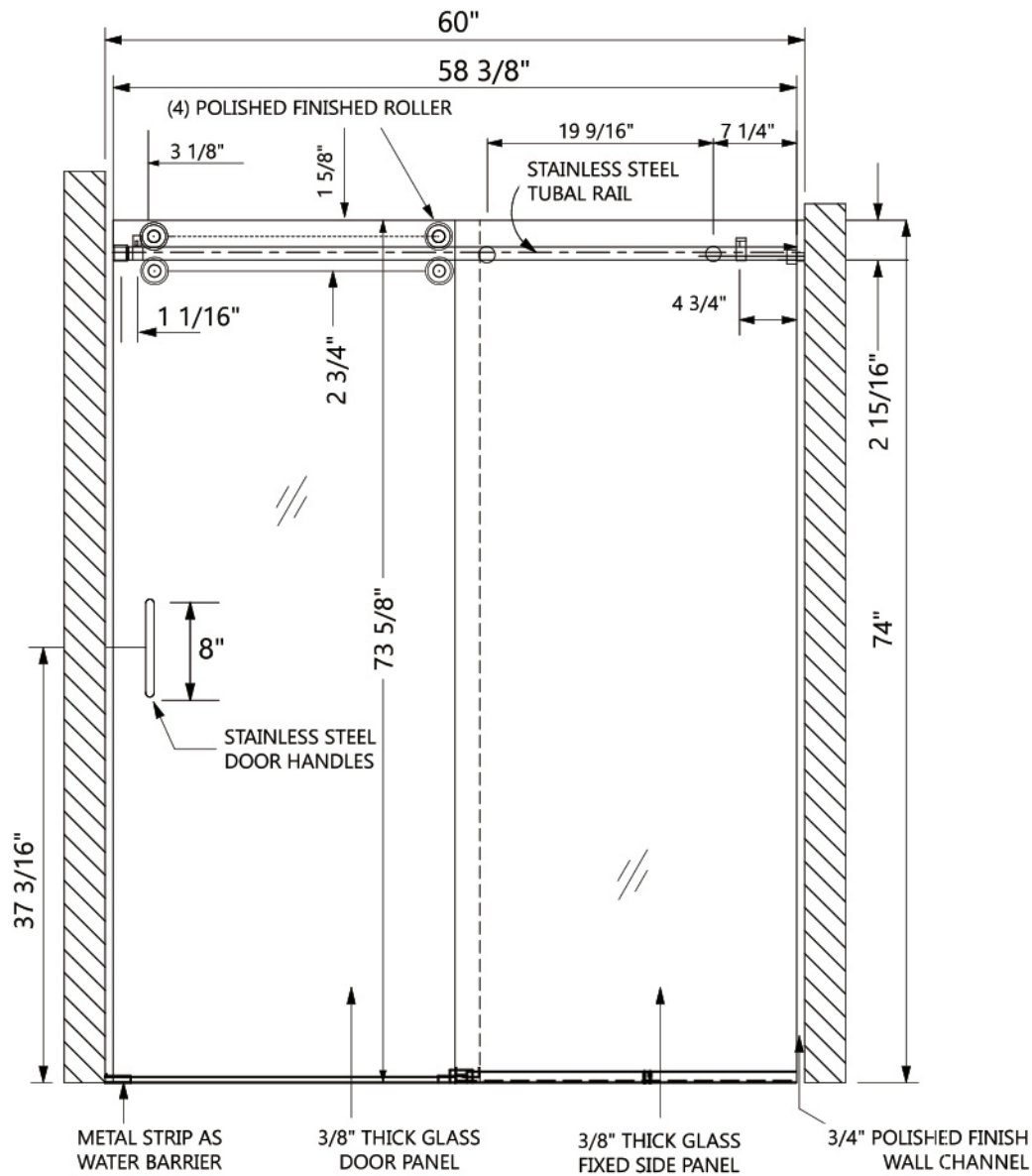

Middleton Associates, LLC

8 Vineland Drive Barrington, Rhode Island 02806
 401-588-4646
 ma_LLC@cox.net

MIDDLETON OMNI

APPROVED BY _____
 COMPANY _____
 DATE _____

MIDDLETON CLASSIC BY-PASS DOOR SYSTEM

FEATURES:

- Frameless By-Pass shower door
- Both doors glide (open)
- 3/8" (10mm) or 5/16" (8mm) thick safety tempered glass
- Continuous door guide for effortless sliding
- Stainless steel hardware
- Aluminum track and profile
- Polished silver finish /Brushed silver finish available



STANDARD SIZE: 60" X 78"

CUSTOM SIZES AVAILABLE

Middleton Associates, LLC

8 Vineland Drive Barrington, Rhode Island 02806

401-588-4646

ma_LLC@cox.net

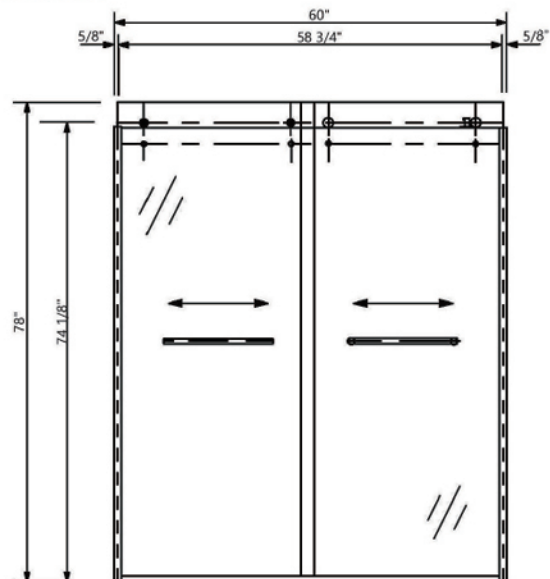

It's all about the glide!

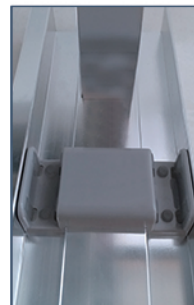

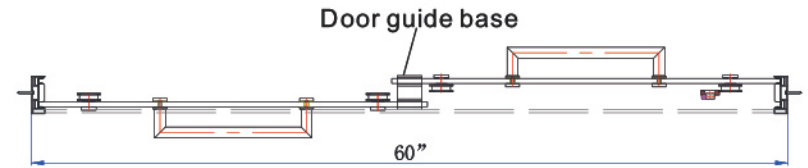
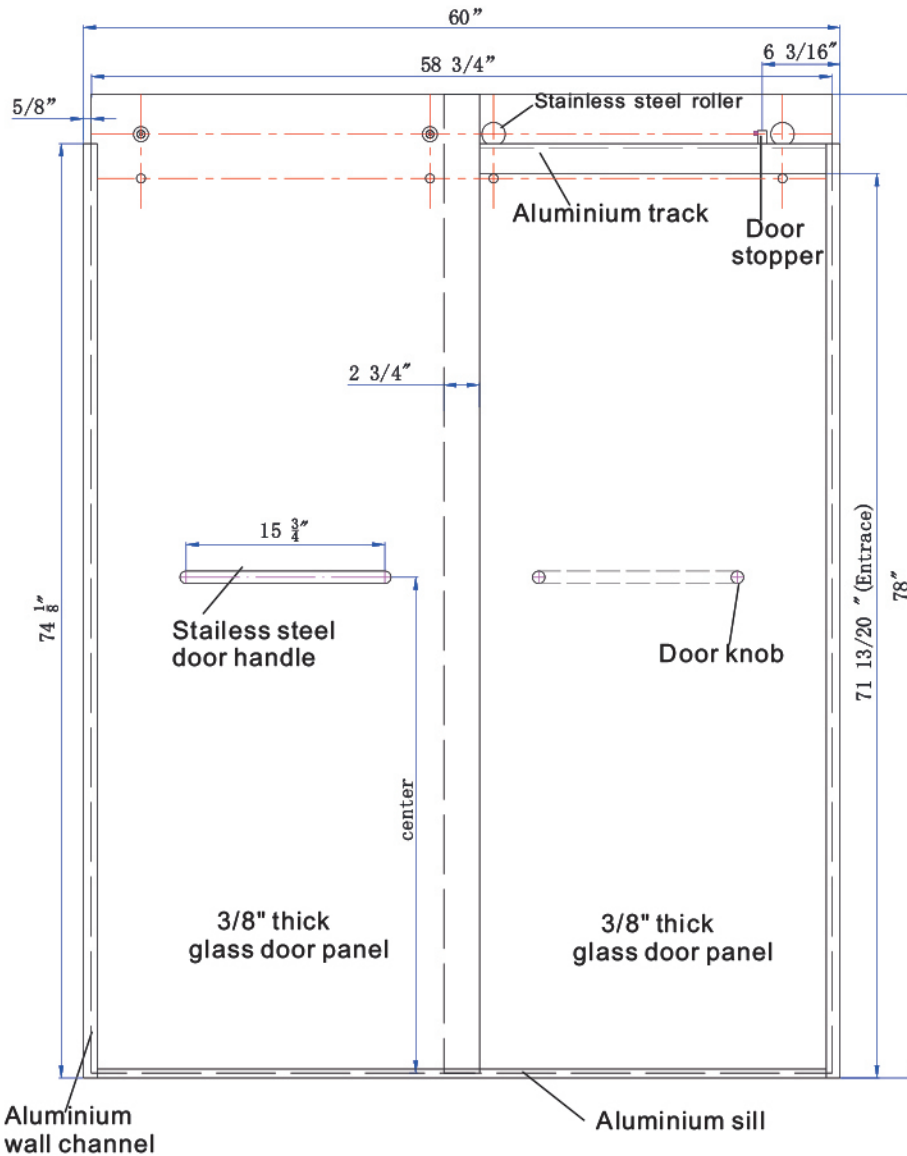

Middleton Associates, LLC

8 Vineland Drive Barrington, Rhode Island 02806
 401-588-4646
 ma_LLC@cox.net

MIDDLETON CLASSIC

APPROVED BY _____
 COMPANY _____
 DATE _____

MIDDLETON OASIS

CURVED GLASS DOOR AND PANEL SYSTEM

FEATURES:

- Smooth Slide Action
- Adjustable Fit
- 5/16" (8mm) Tempered Safety Glass
- Polished or Brushed silver finish available

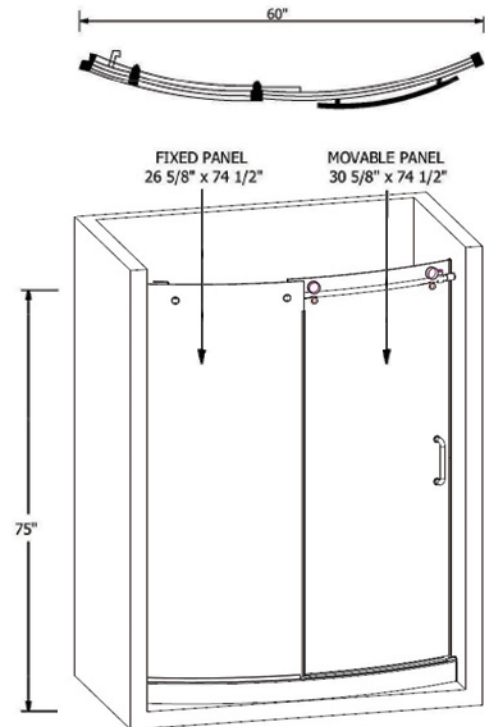

Standard Size: 60" X 74"

Custom Sizes Available

It's all about the glide!



Middleton Associates, LLC

8 Vineland Drive Barrington, Rhode Island 02806

401-588-4646

ma_LLC@cox.net

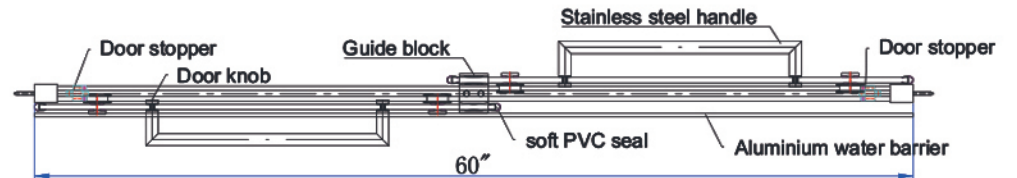
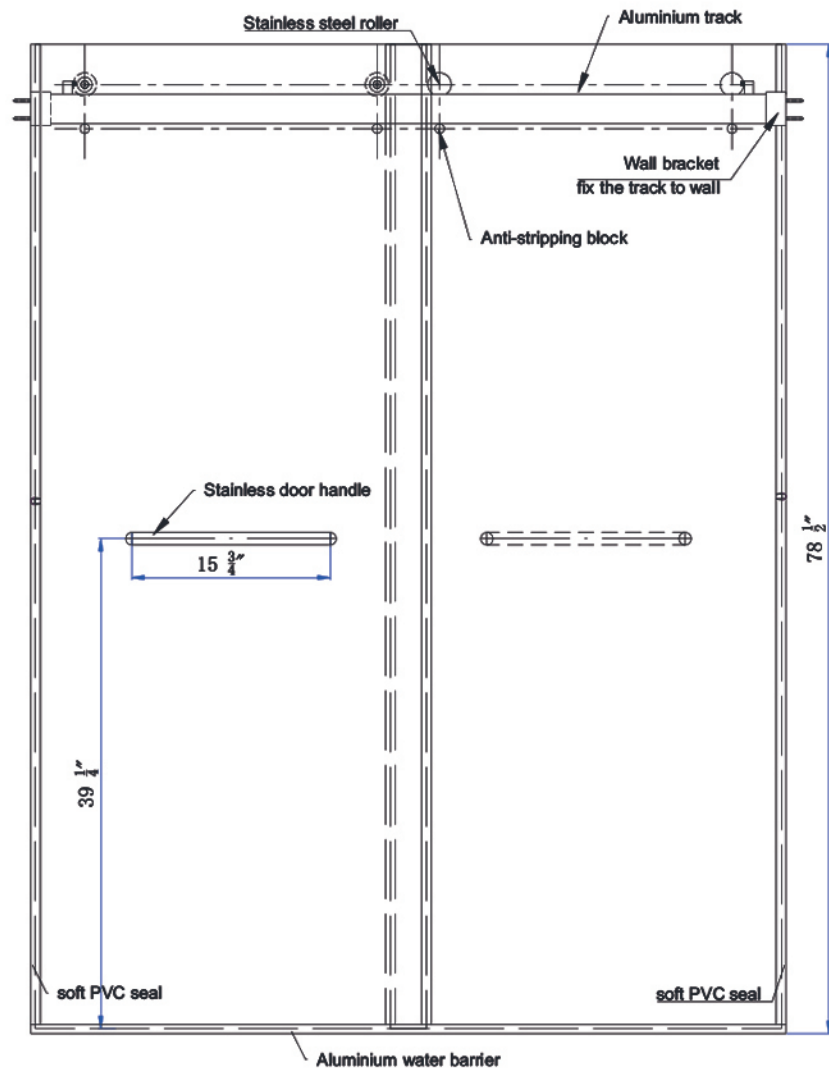

Middleton Associates, LLC

8 Vineland Drive Barrington, Rhode Island 02806
 401-588-4646
 ma_LLC@cox.net

MIDDLETON CLASSIC (NO. WALL PROFILE)

APPROVED BY _____
 COMPANY _____
 DATE _____

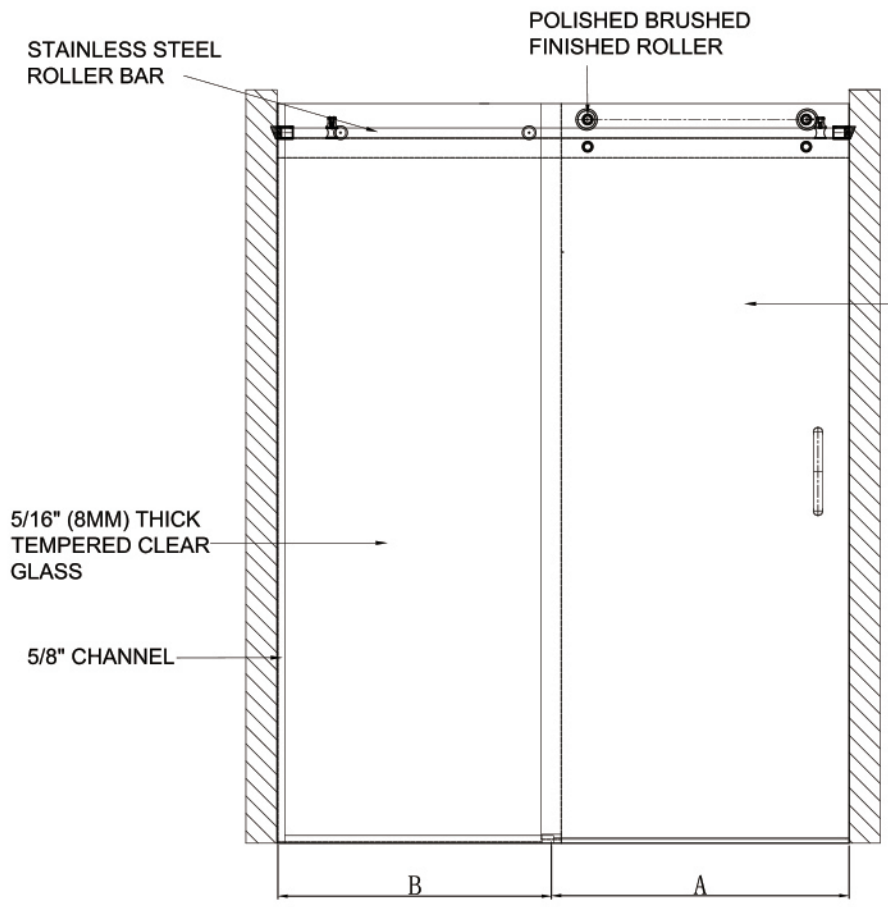

8MM THICK TEMPERED CLEAR GLASS

5/16" (8MM) THICK TEMPERED CLEAR GLASS

5/8" CHANNEL

B

A

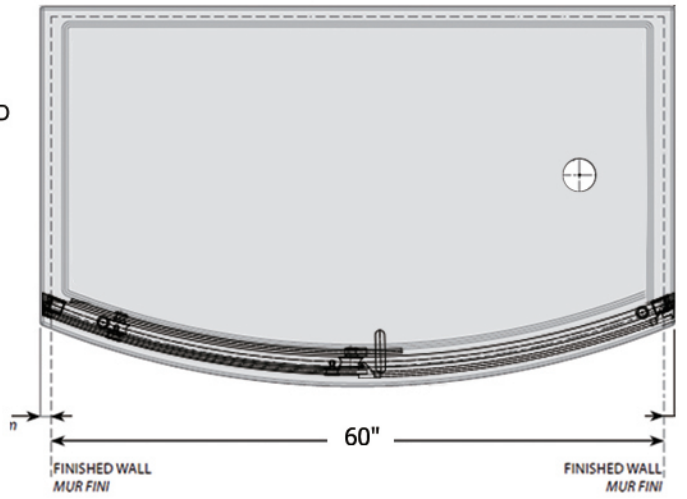

PLAN VIEW

DESCRIPTION	LOCATION	LENGTH	WIDTH	THICK	SQFT	CUFT
DOOR	A	30 5/8"	74 1/2"	5/16"-8MM	744.68	19.39
FIXED PANEL	B	26 5/8"	74 1/2"	5/16"-8MM	671.73	17.49

MATERIAL: TEMPERED GLASS (5/16")

Middleton Associates, LLC

8 Vineland Drive Barrington, Rhode Island 02806
 401-588-4646
 ma_LLC@cox.net

MIDDLETON OASIS

APPROVED BY _____
 COMPANY _____
 DATE _____

MIDDLETON CLEARVIEW GLASS DOOR AND PANEL SYSTEM



FEATURES:

- Ease of Operation
- Adjustability
- Custom Size Available
- 10 mm Tempered Safety Glass
- Stainless Steel Hardware

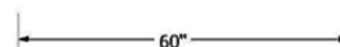
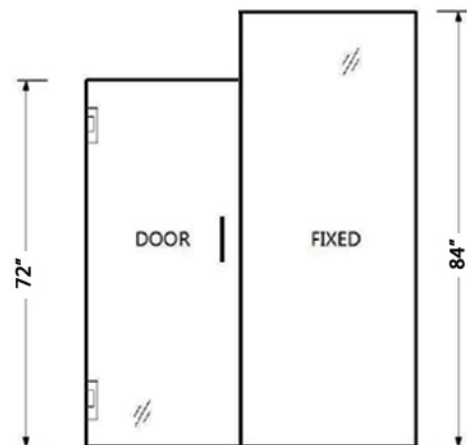
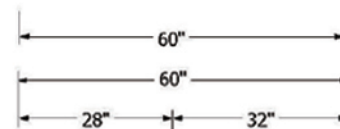
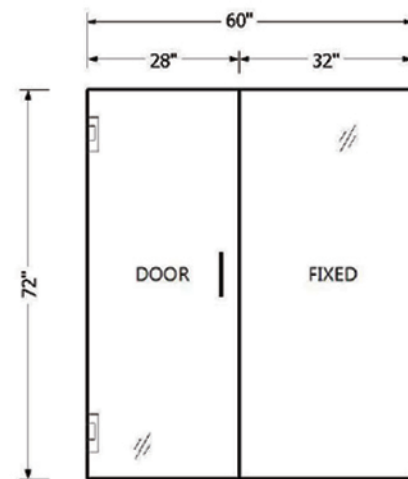

Sizes: 72"x 60" and 84" x 60"

Custom Sizes Available

Middleton Associates, LLC

8 Vineland Drive Barrington, Rhode Island 02806

401-588-4646

ma_LLC@cox.net

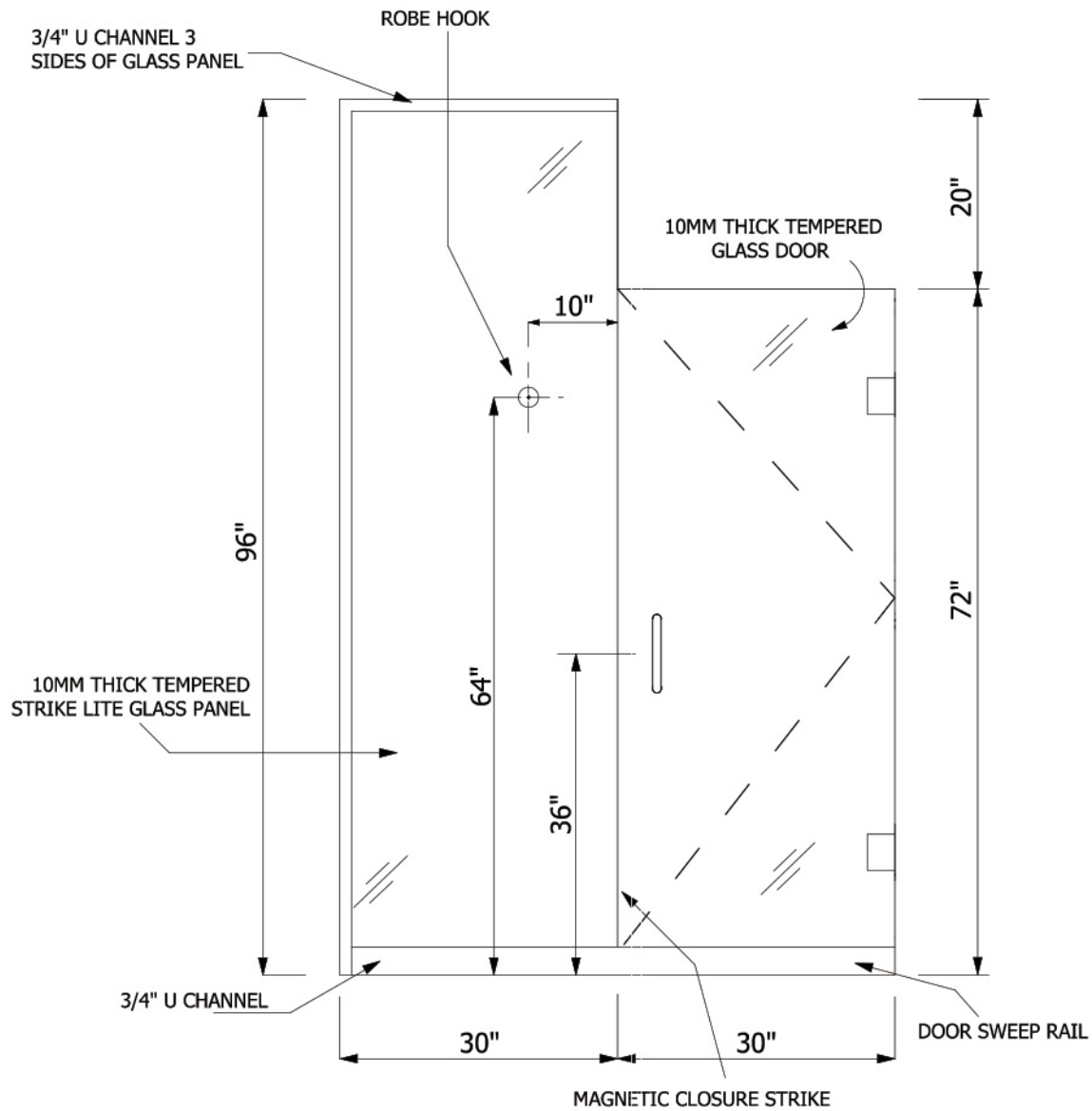

Middleton Associates, LLC

8 Vineland Drive Barrington, Rhode Island 02806

401-588-4646

ma_LLC@cox.net

MIDDLETON CLEARVIEW

APPROVED BY _____

COMPANY _____

DATE _____

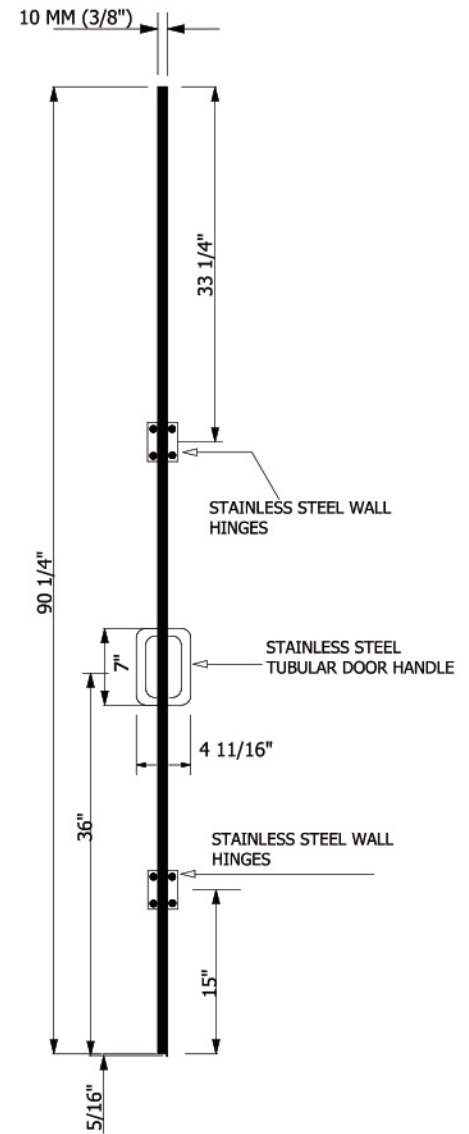
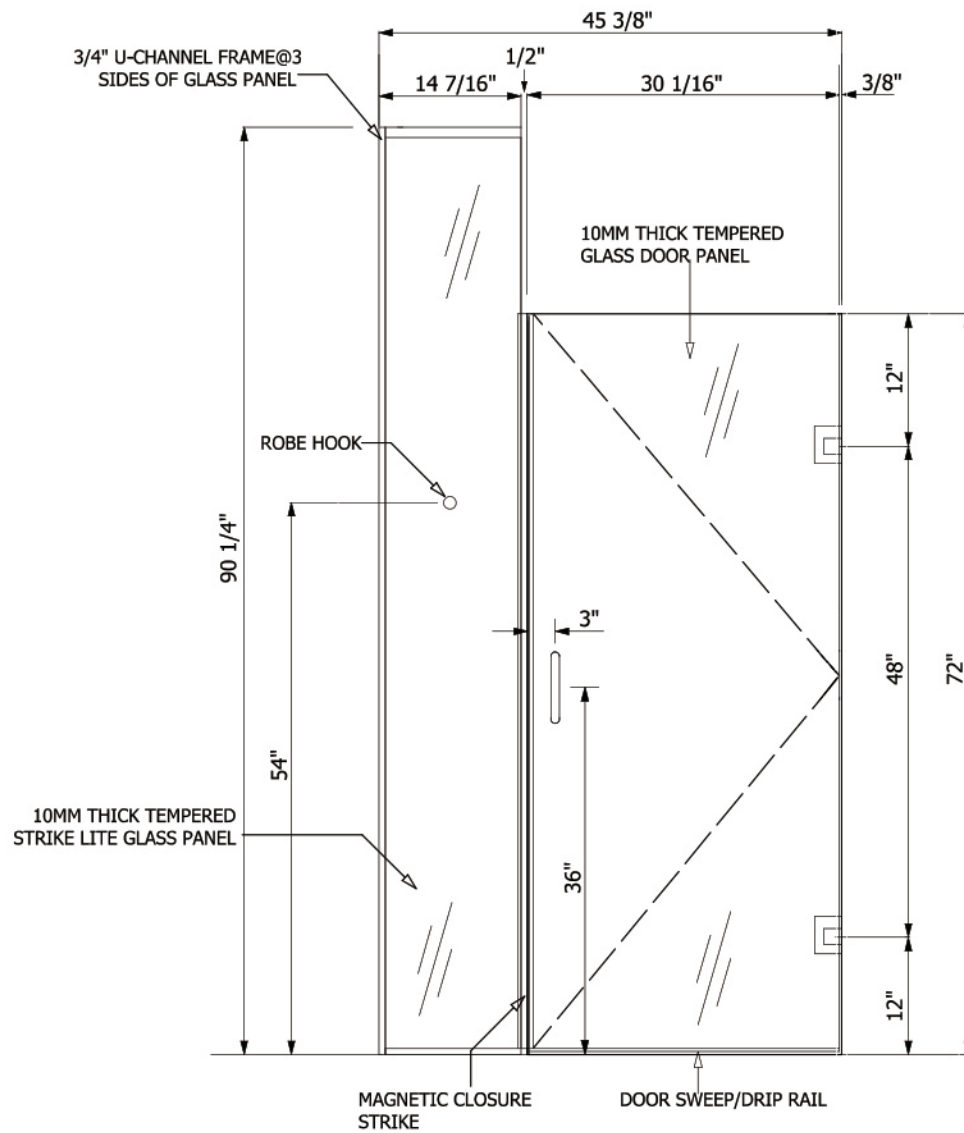

Middleton Associates, LLC

8 Vineland Drive Barrington, Rhode Island 02806

401-588-4646

ma_LLC@cox.net

MIDDLETON CLEARVIEW

APPROVED BY _____

COMPANY _____

DATE _____

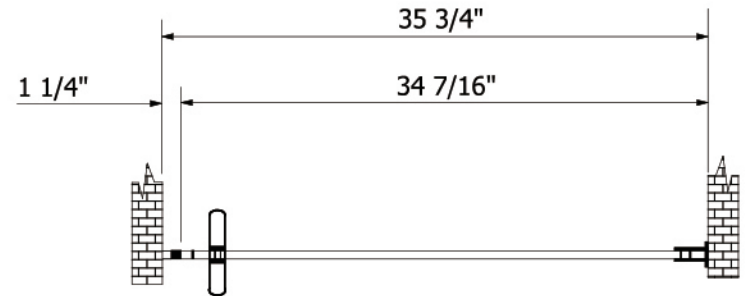
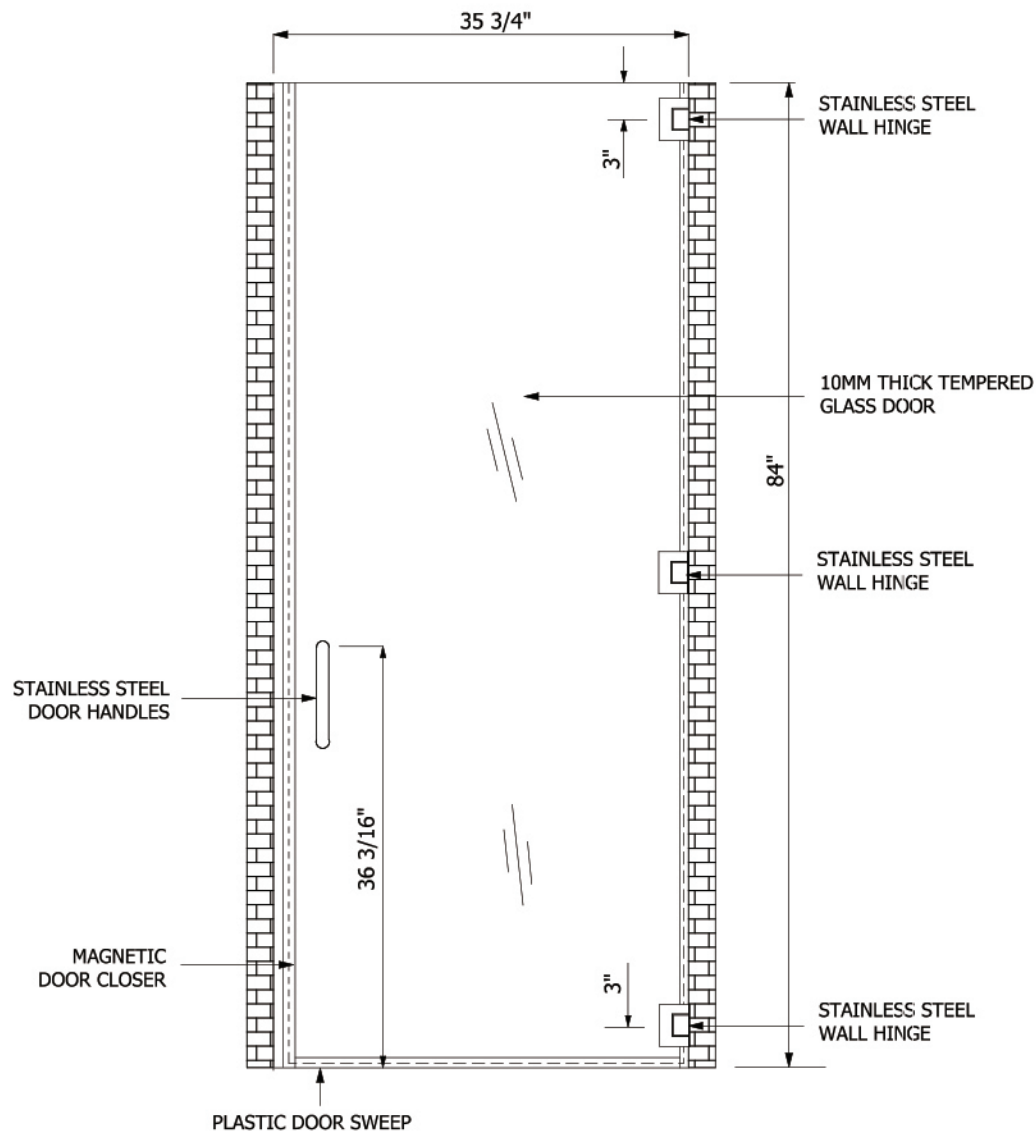

Middleton Associates, LLC

8 Vineland Drive Barrington, Rhode Island 02806
 401-588-4646
 ma_LLC@cox.net

MIDDLETON CLEARVIEW

APPROVED BY _____
 COMPANY _____
 DATE _____

MIDDLETON DYNASTY GLASS DOOR AND PANEL SYSTEM



FEATURES:

- Ease of Operation
- Adjustability
- Custom Size Available
- 10 mm Tempered Safety Glass
- Stainless Steel Hardware

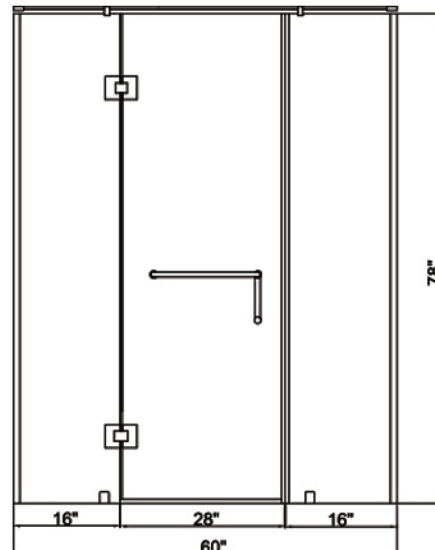
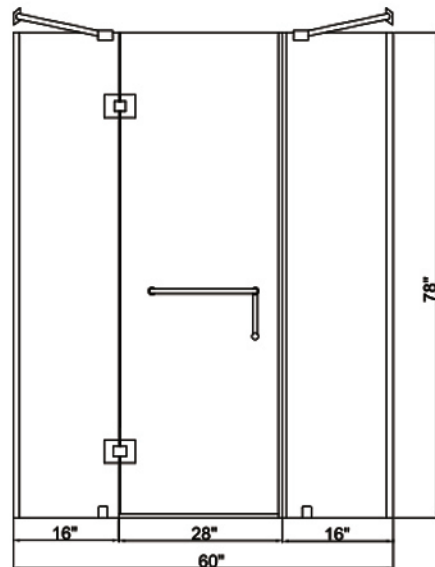

Middleton Associates, LLC

8 Vineland Drive Barrington, Rhode Island 02806

401-588-4646

ma_LLC@cox.net

Sizes: 60" x 78"

Custom Sizes Available

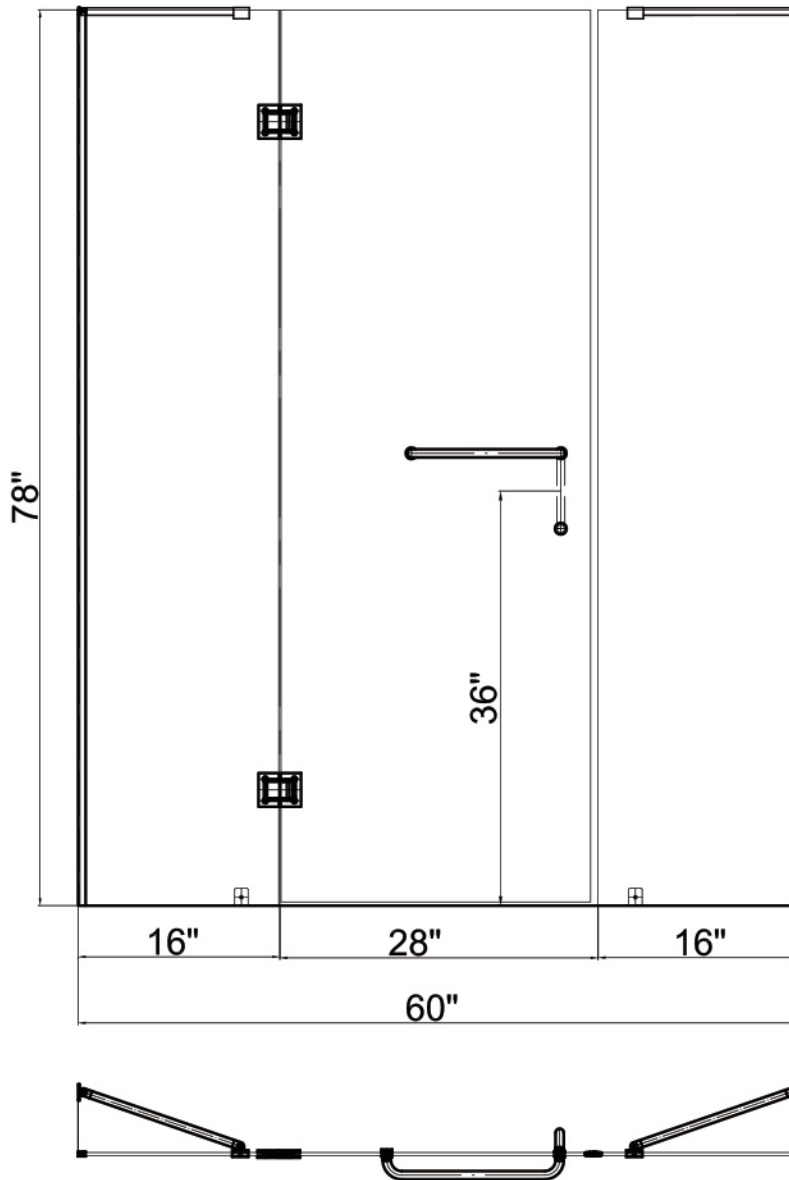

Middleton Associates, LLC

8 Vineland Drive Barrington, Rhode Island 02806
 401-588-4646
 ma_LLC@cox.net

MIDDLETON DYNASTY

APPROVED BY _____
 COMPANY _____
 DATE _____



safety glazing certification council

Administrative Office, AMS, Inc.
205 West Main Street, PO Box 730
Sackets Harbor, NY 13685
Phone: (315)646-2234
E-mail: staff@ams-cert.com

ACKNOWLEDGEMENT OF CERTIFICATION

THIS IS TO ACKNOWLEDGE THAT AS OF THIS DATE

Foshan Nanhai Gangsheng Tempered Glass Factory Foshan, Guangdong, China

IS A CURRENT LICENSEE AND HAS MET ALL GUIDELINES AND REQUIREMENTS FOR THE SGCC® CERTIFICATION PROGRAM AND AS SUCH IS ELIGIBLE TO LABEL THE BELOW INDICATED PRODUCT(S) AS SGCC® CERTIFIED. REPRESENTATION SAMPLES OF THE BELOW PRODUCTS HAVE BEEN FOUND TO BE IN COMPLIANCE WITH ANSI Z97.1-2009 OR 2015 AS INDICATED, CPSC 16 CFR 1201 STANDARDS, OR BOTH STANDARDS, KNOWN AS COMPOSITE CERTIFICATION (COMP), OR BOTH STANDARDS WITH CAN/CGSB 12.1 KNOWN AS COMP+CAN.

<u>SGCC#</u>	<u>IN</u>	<u>MM</u>	<u>Attributes</u>	<u>INT</u>	<u>Type Code</u>	<u>Max Size</u>	<u>ANSI Class</u>	<u>Test Std</u>	<u>ANSI Z97</u> <u>Year</u>
4669	3/16	5	(IN)		TTG	U	A	COMP+CAN	2009
4670	1/4	6	(IN)		TTG	U	A	COMP+CAN	2009
4671	5/16	8	(IN)		TTG	U	A	COMP+CAN	2009
4672	3/8	10	(IN)		TTG	U	A	COMP+CAN	2009
4673	5/32	4	(IN)		TTG	U	A	COMP+CAN	2009
5549	1/2	12	(IN)		TTG	U	A	COMP+CAN	2009
5550	1/4	6	(IN)		TBG	U	A	COMP+CAN	2009
5551	5/16	8	(IN)		TBG	U	A	COMP+CAN	2009
5552	3/8	10	(IN)		TBG	U	A	COMP+CAN	2009

THIS SGCC® PROGRAM CERTIFICATION IS CURRENT AND IN FULL EFFECT AS OF THIS ISSUE DATE. CERTIFICATION IN THE SGCC® PROGRAM IS SUBJECT TO SEMI-ANNUAL RENEWAL. PLEASE CHECK THE SGCC WEBSITE AT WWW.SGCC.ORG OR THIS OFFICE FOR MOST CURRENT INFORMATION.

Friday, April 21, 2017
DATE OF ISSUE

F17
CERTIFICATION PERIOD

ADMINISTRATIVE MANAGER